



THE MONROE TRADITIONAL



CHARTER Homes & Neighborhoods



THE MONROE CLASSIC



CHARTER Homes & Neighborhoods



SHOWN WITH OPTIONAL DORMERS

THE MONROE ESTATE



CHARTER Homes & Neighborhoods



THE MONROE FORMAL



CHARTER Homes & Neighborhoods

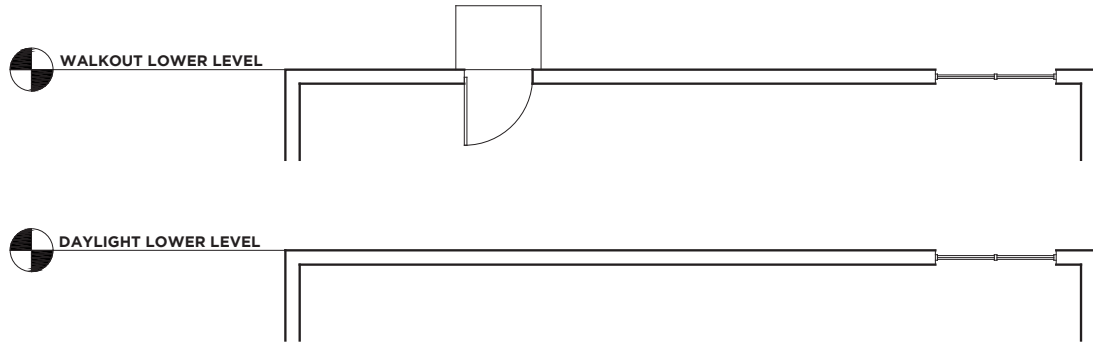

LOWER LEVEL
 ADD 1FT TO BASEMENT WALLS
 BASEMENT BATH ROUGH IN

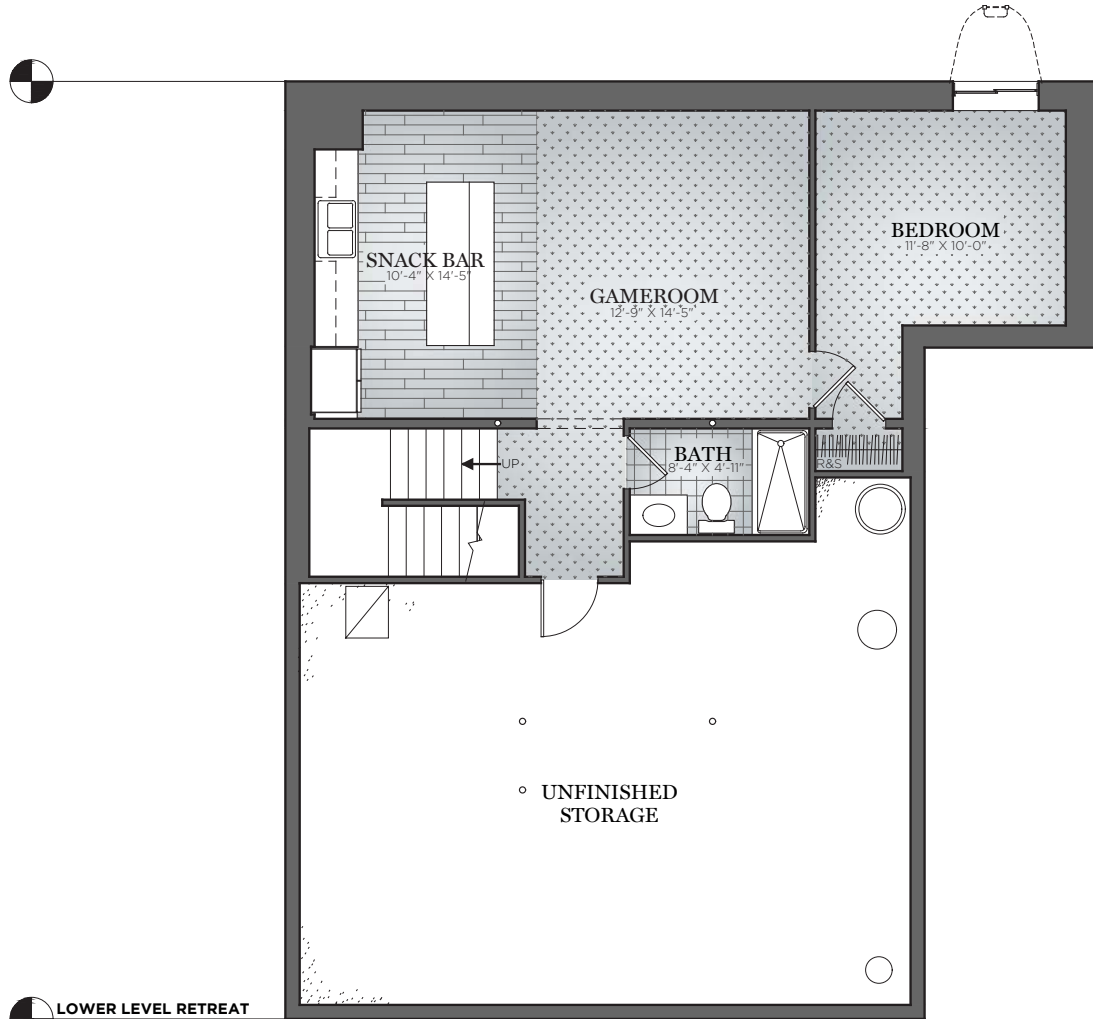

LOWER LEVEL RETREAT
 +683 SQ.FT.
 ADD 1FT TO BASEMENT WALLS INCLUDED
 WITH LOWER LEVEL GAMEROOM

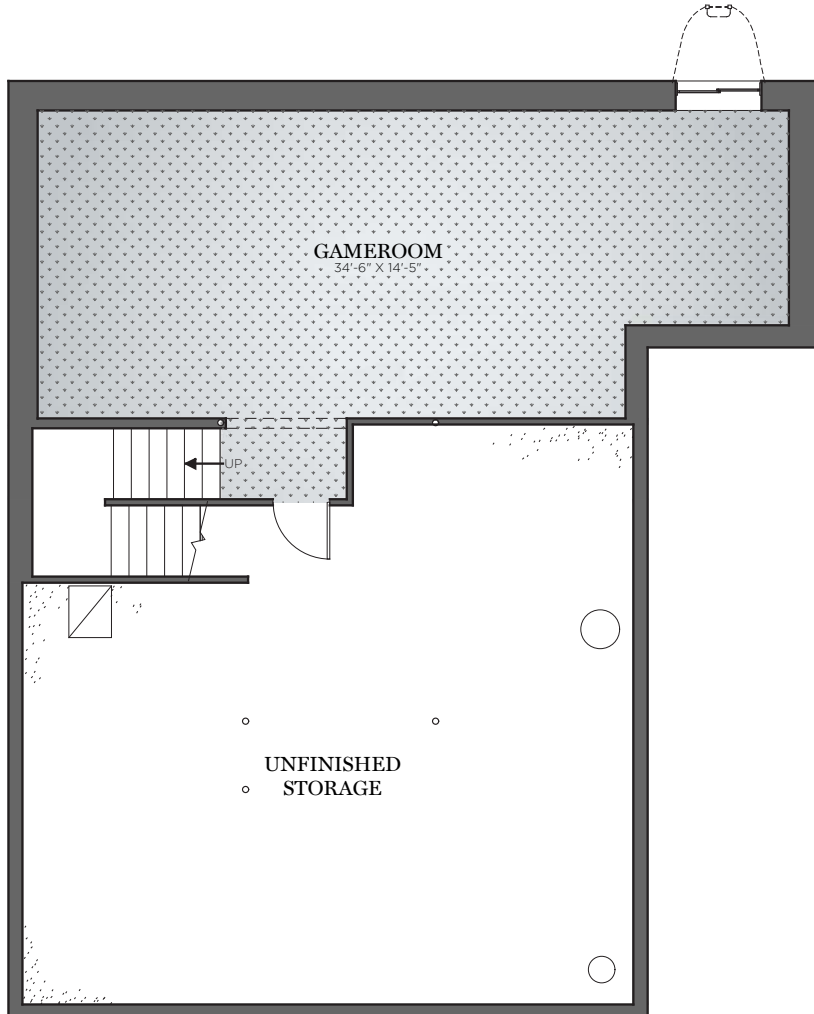

ADD 1FT TO BASEMENT WALLS INCLUDED
 WITH LOWER LEVEL GAMEROOM
 LOWER LEVEL GAMEROOM
 +616 SQ.FT.

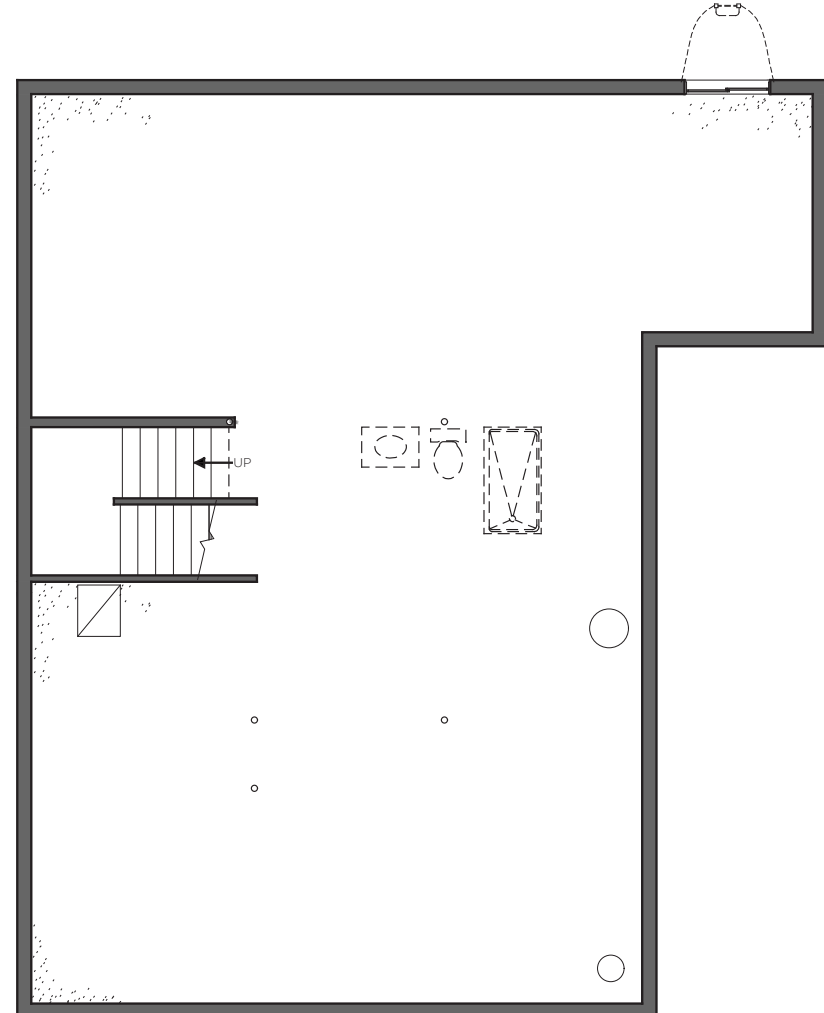

LOWER LEVEL MODIFY FLOOR PLAN
 OA DIMENSION 50 X 49

THE MONROE



CHARTER Homes & Neighborhoods

Information included is for illustrative and marketing purposes only. Scale and dimensions are approximate and may vary based on normal construction tolerances. Renderings, materials, finishes and fixtures are intended for space demonstration only. Consult Neighborhood Sales Manager for accurate details based on individual conditions of Purchase Agreement.
 © 2016 Charter Homes & Neighborhoods. All rights reserved. Do not duplicate or distribute without written consent.

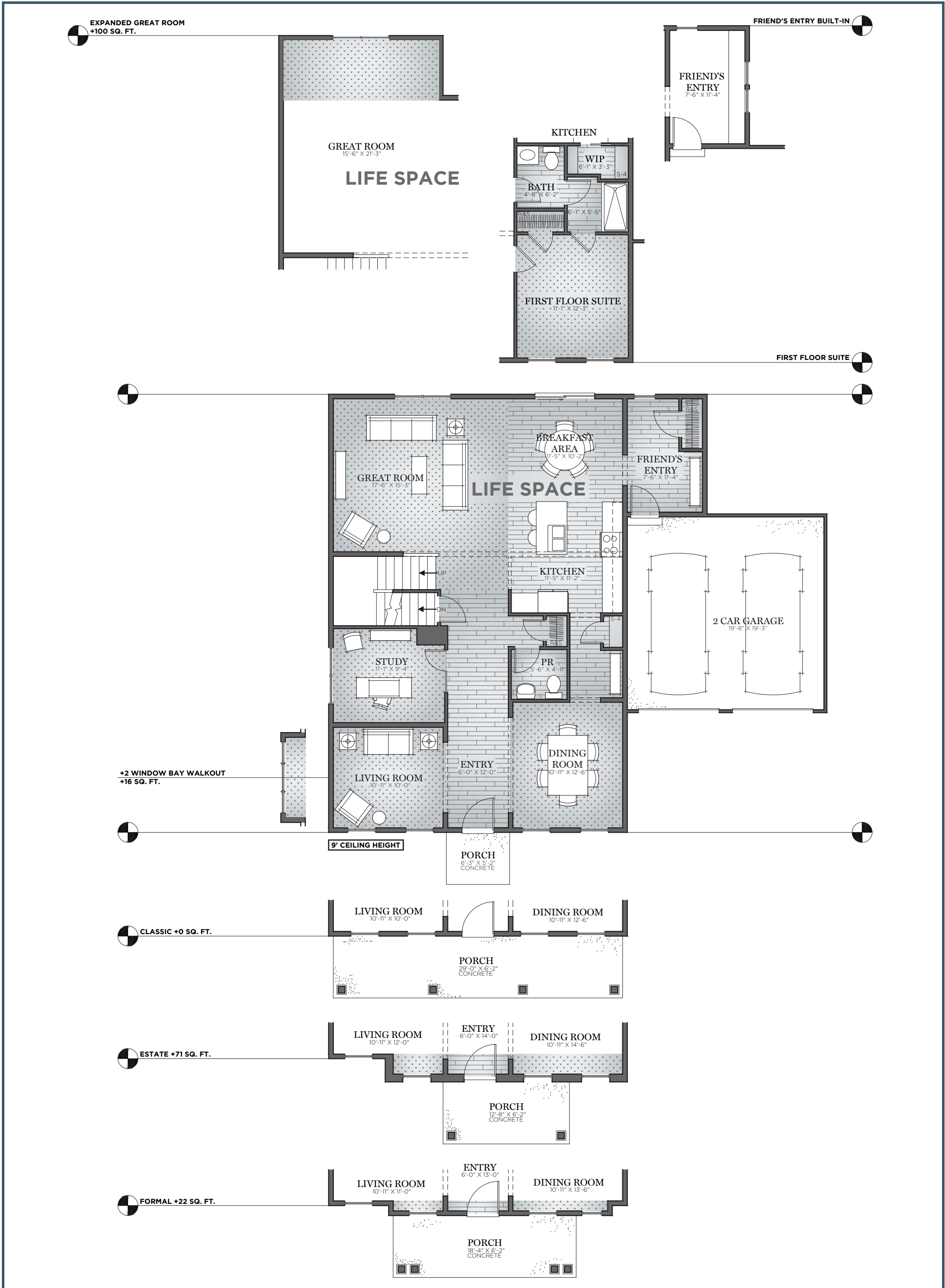

FIRST FLOOR MODIFY FLOOR PLAN
 OA DIMENSION 50 X 49

THE MONROE



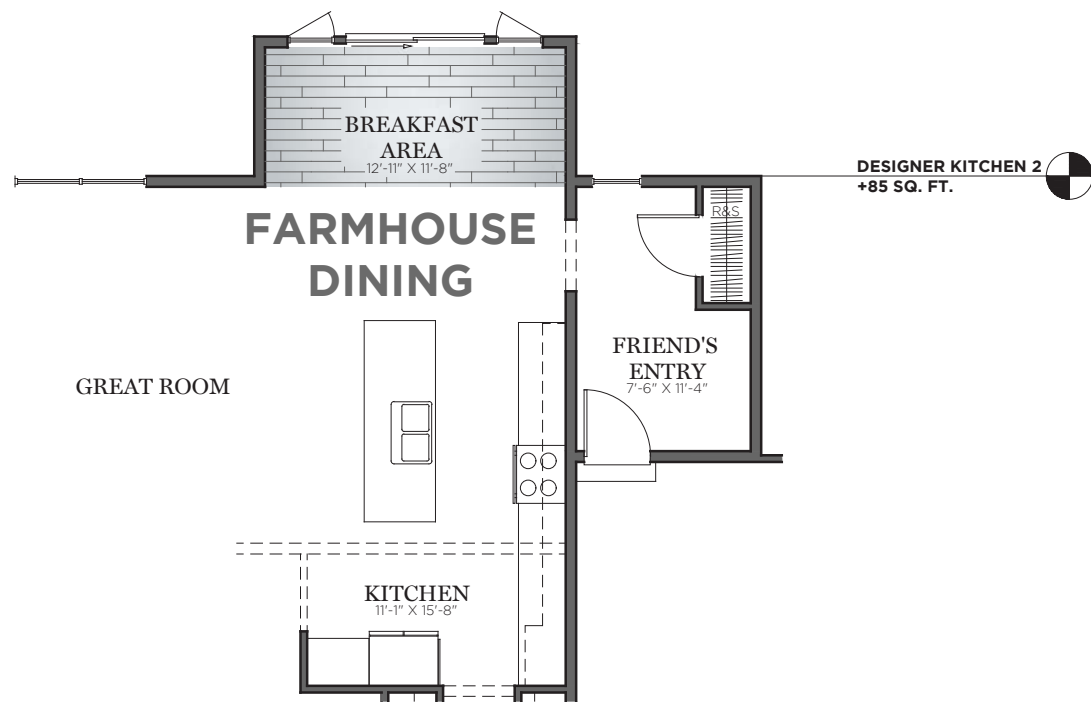
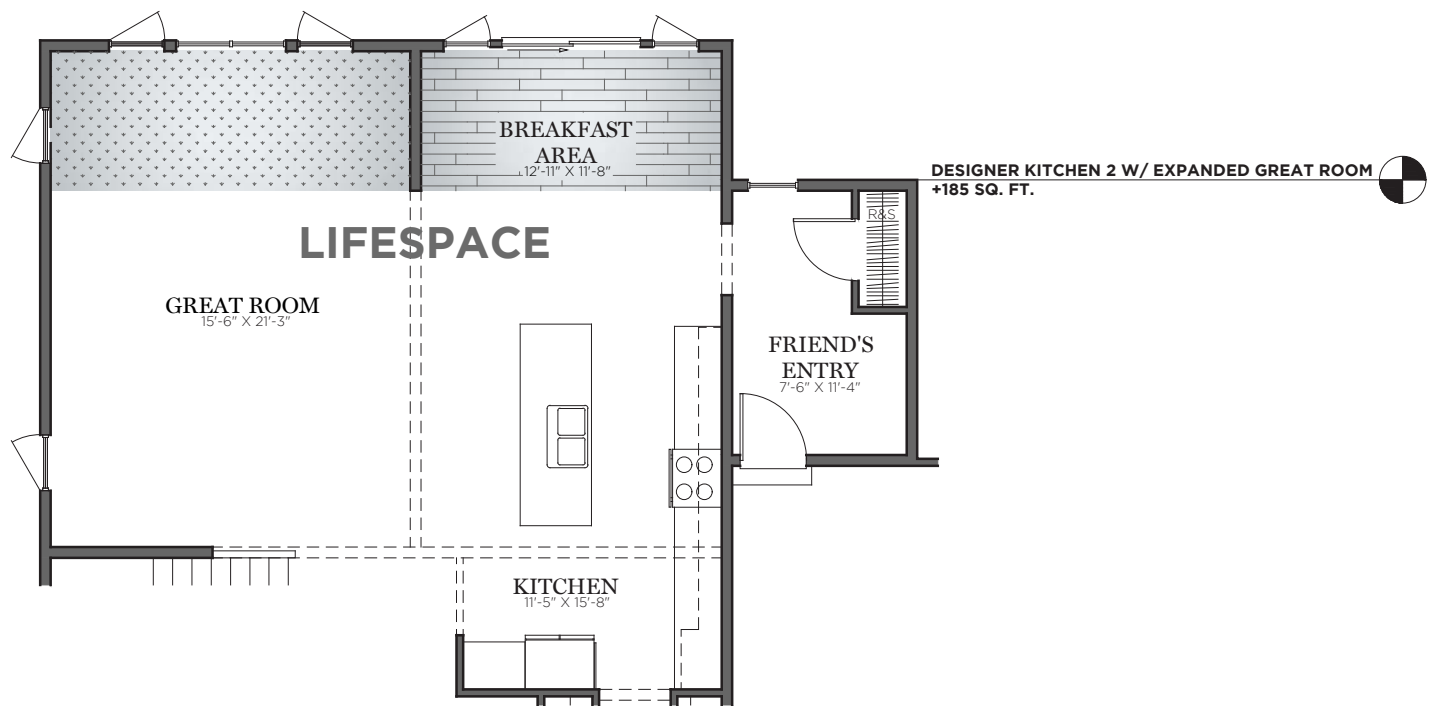
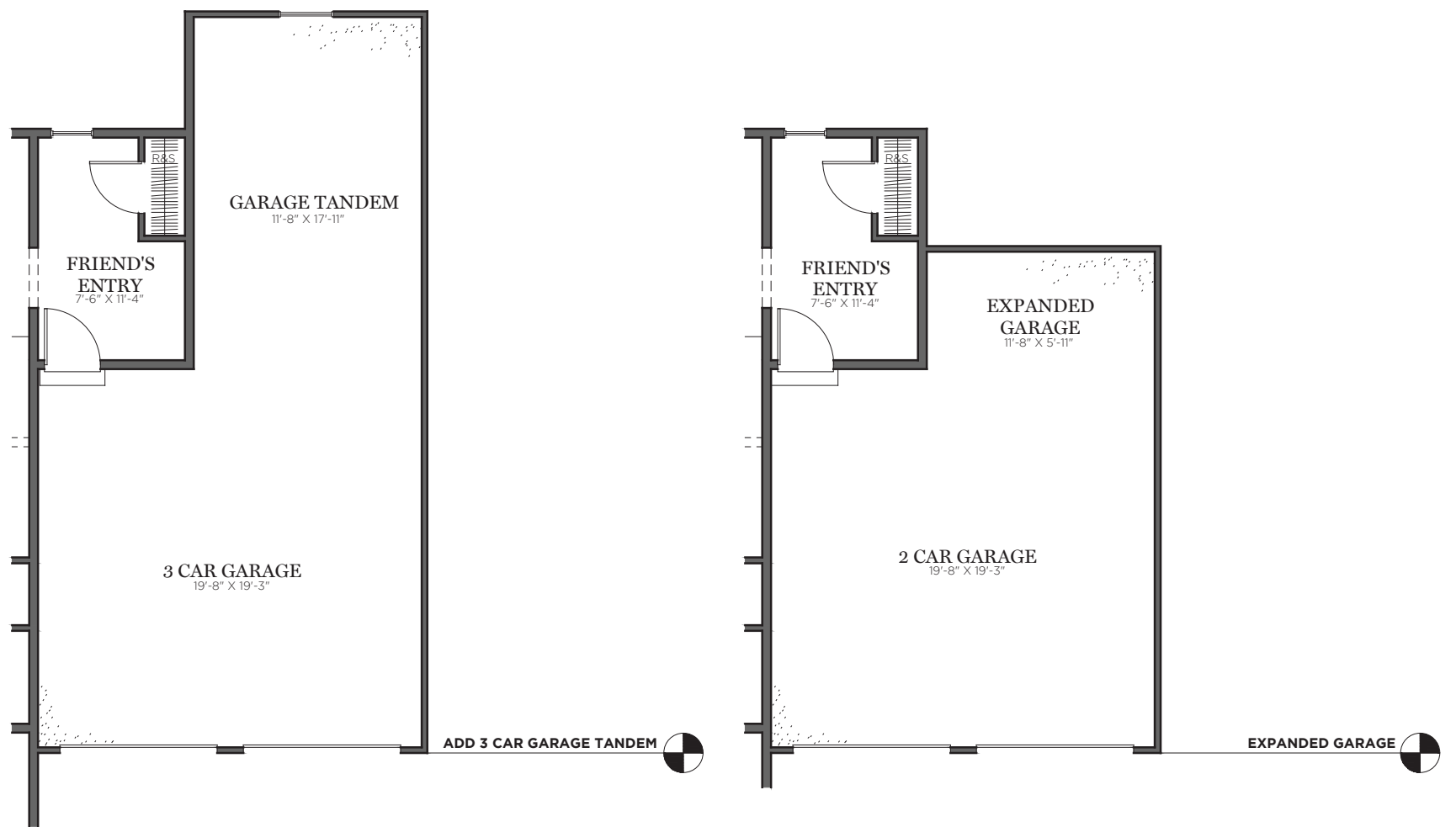

FIRST FLOOR MODIFY FLOOR PLAN
 OA DIMENSION 50 X 49

THE MONROE



CHARTER Homes & Neighborhoods

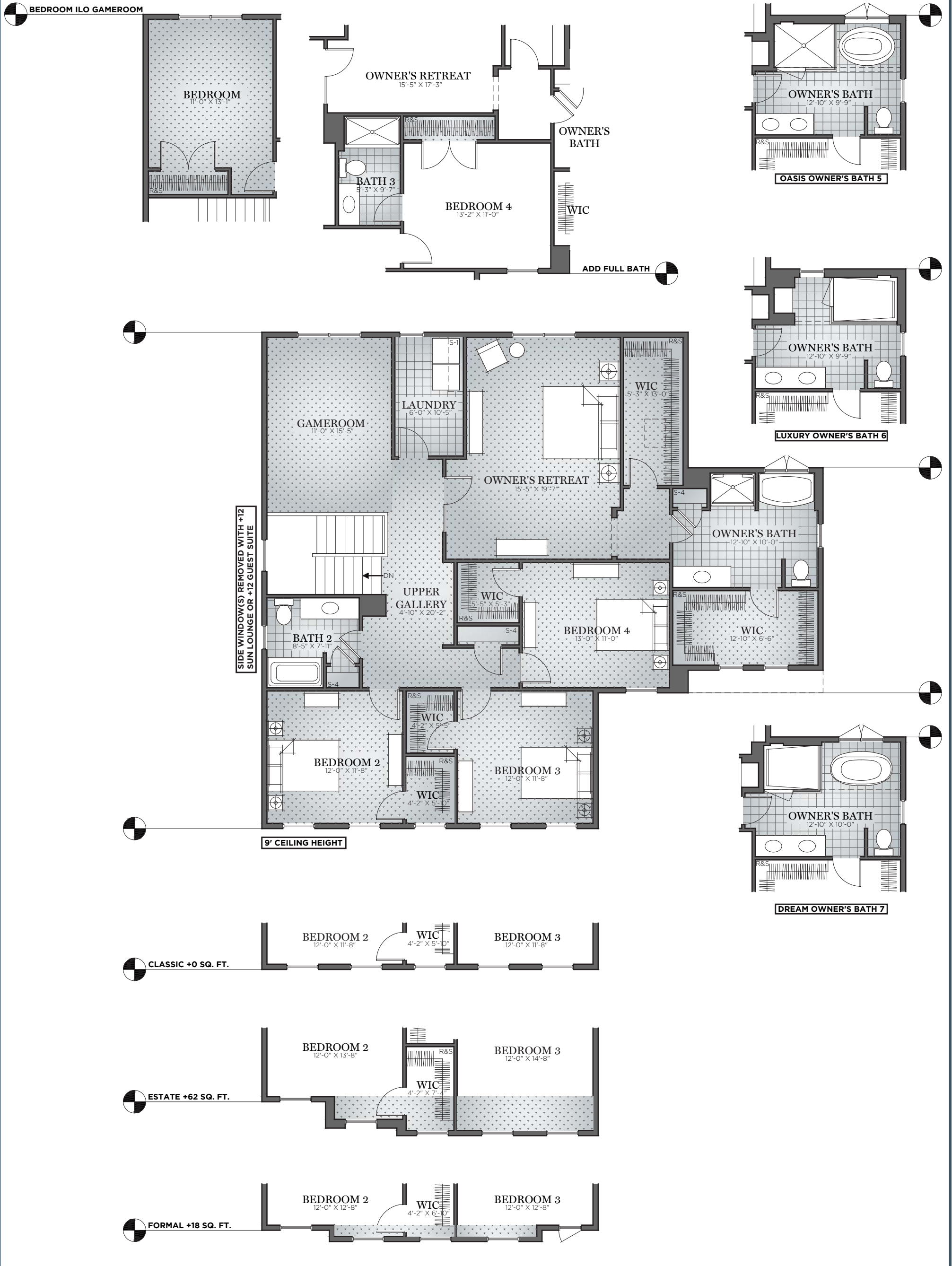

SECOND FLOOR MODIFY FLOOR PLAN
OA DIMENSION 50 X 49

THE MONROE



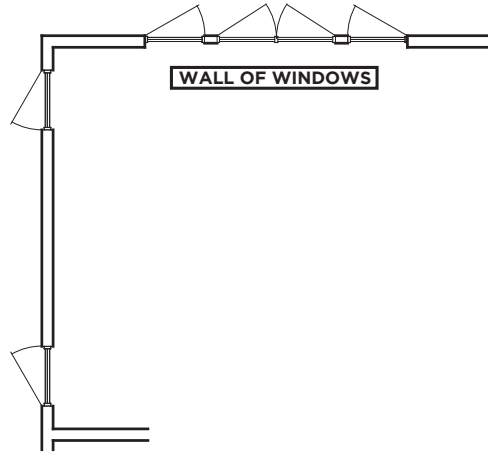

MEDIA CENTER 1
 MEDIA CENTER 2
 ADD SINGLE WINDOW(S)
 FIREPLACE AND MANTLE 1
 STAIR RAIL ILO HALF WALL

TRAY CEILING 2

BARN DOOR

HIDEAWAY DRESSER
 HEIRLOOM BOOKCASE
 FARMHOUSE BENCH

ADD SINGLE WINDOW NOT AVAIL. WITH MEDIA CENTER 1 & 2

MEDIA CENTER 1/
 MEDIA CENTER 2
 LOCATION IN GREAT ROOM

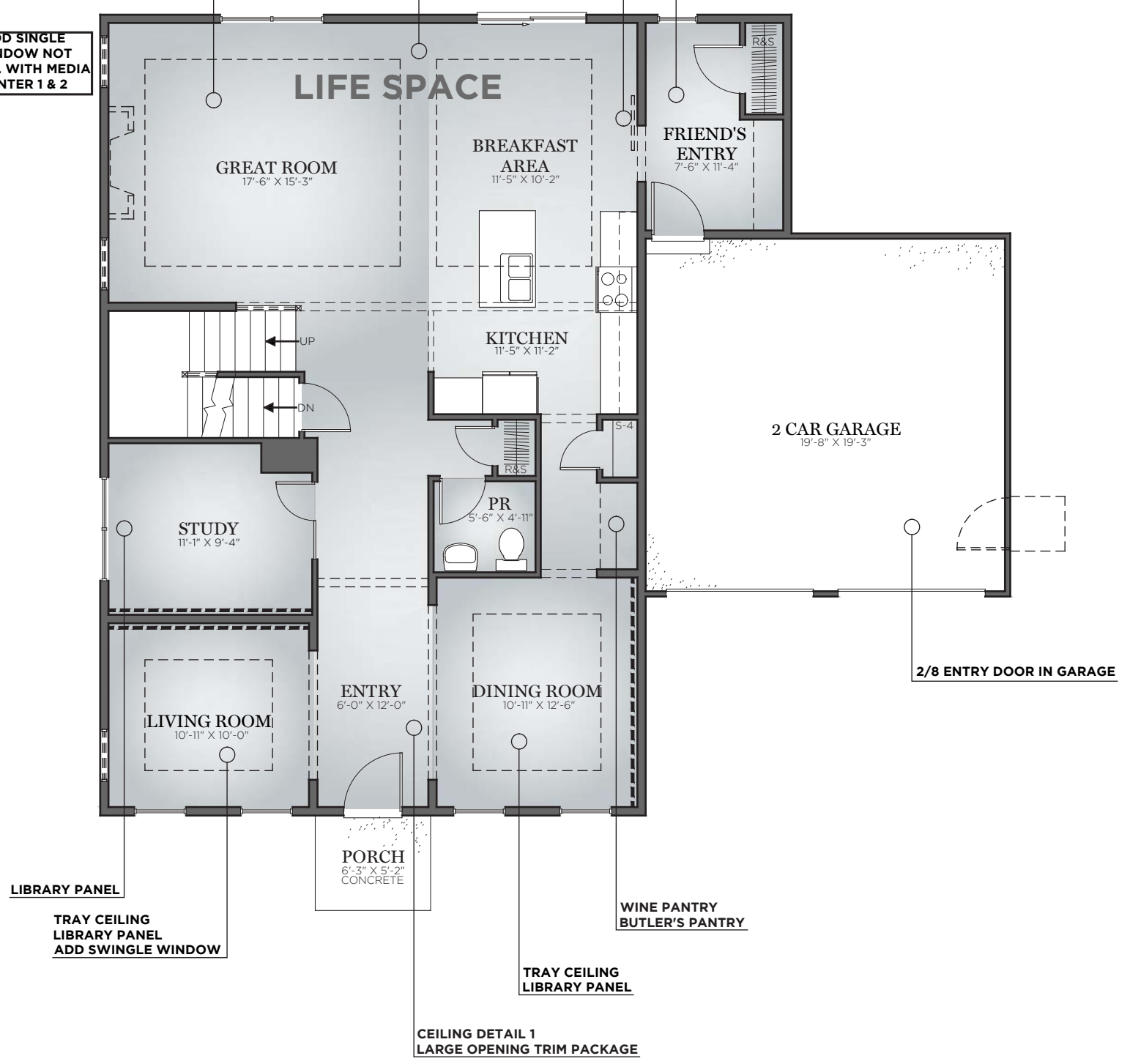

FIRST FLOOR ADD DETAILS
 OA DIMENSION 50 X 49

THE MONROE



CHARTER Homes & Neighborhoods

Information included is for illustrative and marketing purposes only. Scale and dimensions are approximate and may vary based on normal construction tolerances. Renderings, materials, finishes and fixtures are intended for space demonstration only. Consult Neighborhood Sales Manager for accurate details based on individual conditions of Purchase Agreement.
 © 2016 Charter Homes & Neighborhoods. All rights reserved. Do not duplicate or distribute without written consent.

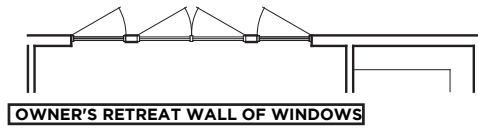

SECOND FLOOR ADD DETAILS
OA DIMENSION 50 X 49

THE MONROE



CHARTER Homes & Neighborhoods



 **CHARTER** Homes & Neighborhoods

CLASSIC
KITCHEN B

THE MONROE

Island Top Dimensions are 3'-1" x 5'-3"
 Wall Cabinet height 42"
 Appliance finish and features will vary per selection
 Refrigerator is not included in appliance package
 Finishes including cabinets, flooring, lighting, tile, plumbing,
 and hardware to be selected at Charter Colors
 Pendant lighting not included

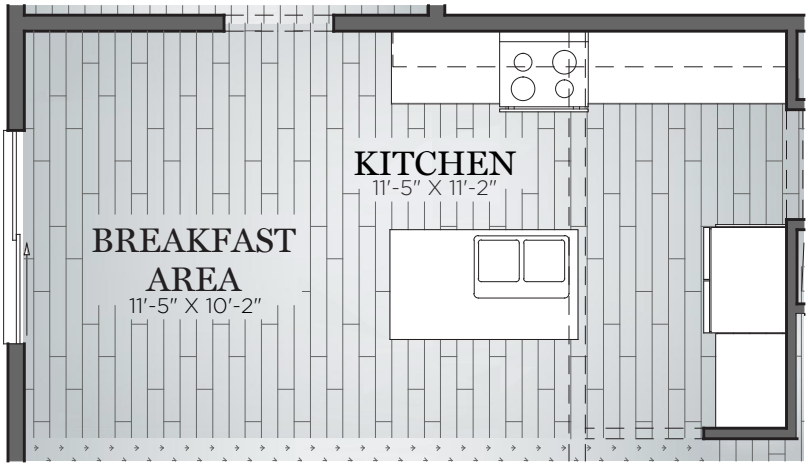

PLAN

Information included is for illustrative and marketing purposes only. Scale and dimensions are approximate and may vary based on normal construction tolerances. Renderings, materials, finishes and fixtures are intended for space demonstration only. Consult Neighborhood Sales Manager for accurate details based on individual conditions of Purchase Agreement. © 2016 Charter Homes & Neighborhoods. All rights reserved. Do not duplicate or distribute without written consent. ☎ 3223-3713 | 4 | 2.5 | v.2203



 **CHARTER** Homes & Neighborhoods

DESIGNER
KITCHEN 2

THE **MONROE**

Island Top Dimensions are 3'-1" x 8'-8"
 Wall Cabinet height 42"
 Appliance finish and features will vary per selection
 Refrigerator is not included in appliance package
 Finishes including cabinets, flooring, lighting, tile, plumbing,
 and hardware to be selected at Charter Colors
 Pendant lighting not included

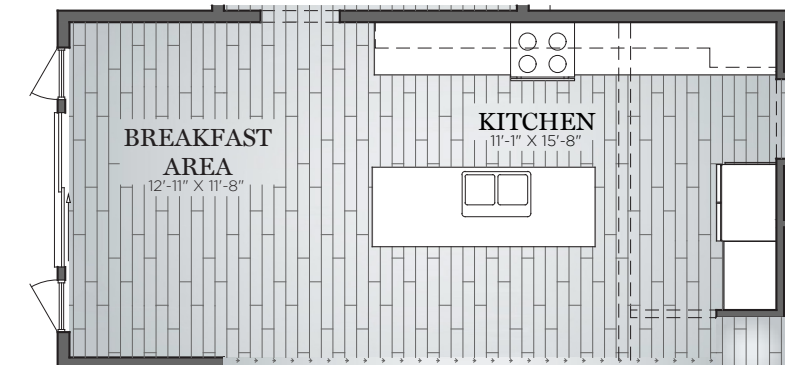

PLAN



 **CHARTER** Homes & Neighborhoods

CHEF'S KITCHEN 3

THE MONROE

Island Top Dimensions are 3'-8" x 9'-5"
 Wall Cabinet height 42"
 Appliance finish and features will vary per selection
 Refrigerator is not included in appliance package
 Finishes including cabinets, flooring, lighting, tile, plumbing,
 and hardware to be selected at Charter Colors
 Pendant lighting not included

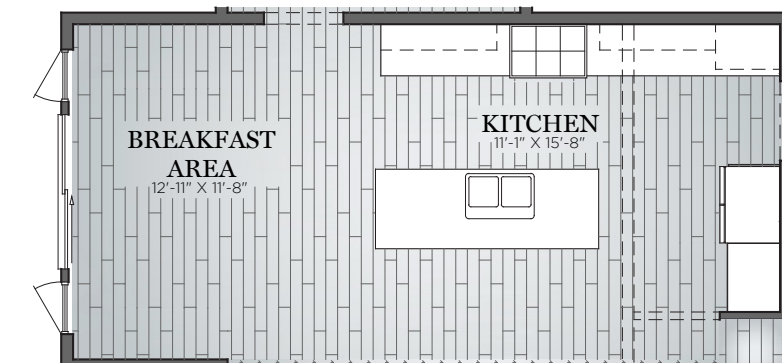

PLAN



SPA OWNER'S BATH 4



RETREAT BATH 3



TRADITIONAL BATH 2

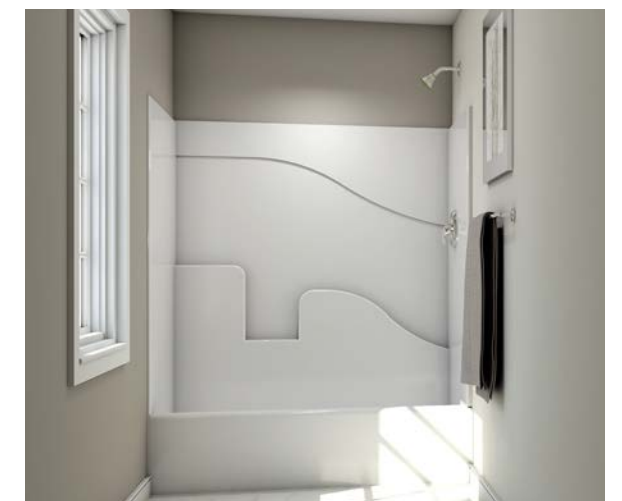

CLASSIC BATH B

 **CHARTER** Homes & Neighborhoods

THE MONROE

Tile locations vary per floorplan
 Bathroom layout varies per floorplan
 Finishes including plumbing, lighting, tile, vanities, sinks,
 and doors to be selected at Charter Colors



OASIS OWNER'S BATH 5



LINEN CABINET
-ADJUSTABLE SHELVES



CHARTER Homes & Neighborhoods

THE **MONROE**

Tile locations vary per floorplan
Bathroom layout varies per floorplan
Finishes including plumbing, lighting, tile, vanities, sinks,
and doors to be selected at Charter Colors



LUXURY OWNER'S BATH 6



LINEN CABINET
-ADJUSTABLE SHELVES



TOWEL CUBBIE CABINET
-FULL REAR WALL OF TILE TO MATCH
SHOWER SELECTION
-WOOD TOP WITH BACKSPASH
-RECESSED LIGHT INCLUDED



CHARTER Homes & Neighborhoods

THE **MONROE**

Tile locations vary per floorplan
Bathroom layout varies per floorplan
Finishes including plumbing, lighting, tile, vanities, sinks,
and doors to be selected at Charter Colors



DREAM OWNER'S BATH 7



CHARTER Homes & Neighborhoods

THE MONROE

Tile locations vary per floorplan
Bathroom layout varies per floorplan
Finishes including plumbing, lighting, tile, vanities, sinks,
and doors to be selected at Charter Colors