



THE DRUMMOND TRADITIONAL



CHARTER Homes & Neighborhoods



THE DRUMMOND CLASSIC



CHARTER Homes & Neighborhoods



THE DRUMMOND FORMAL



CHARTER Homes & Neighborhoods



SHOWN WITH OPTIONAL DORMERS

THE DRUMMOND ESTATE



CHARTER Homes & Neighborhoods

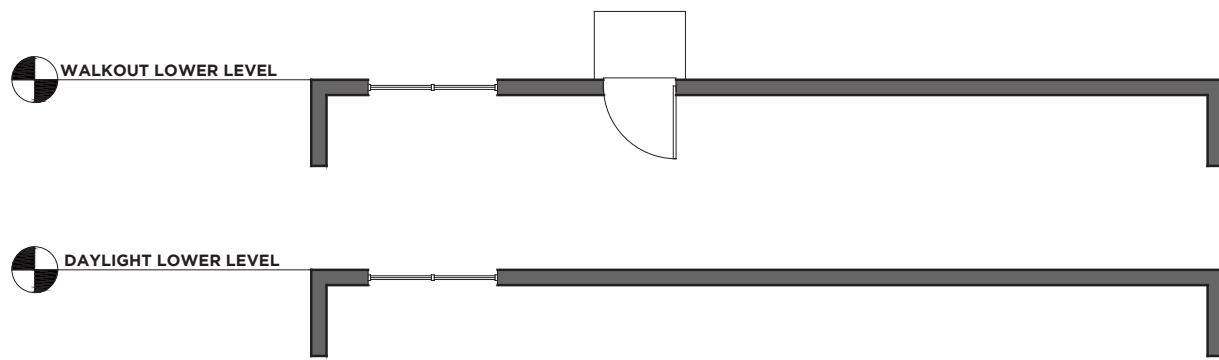

LOWER LEVEL
 ADD 1FT TO BASEMENT WALLS
 BASEMENT BATH ROUGH IN

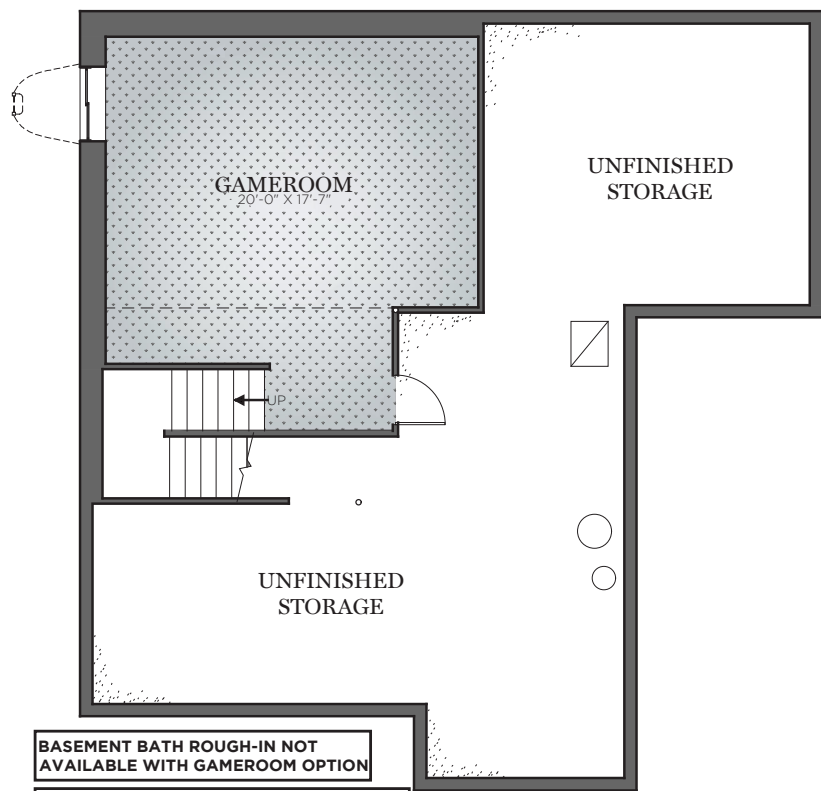
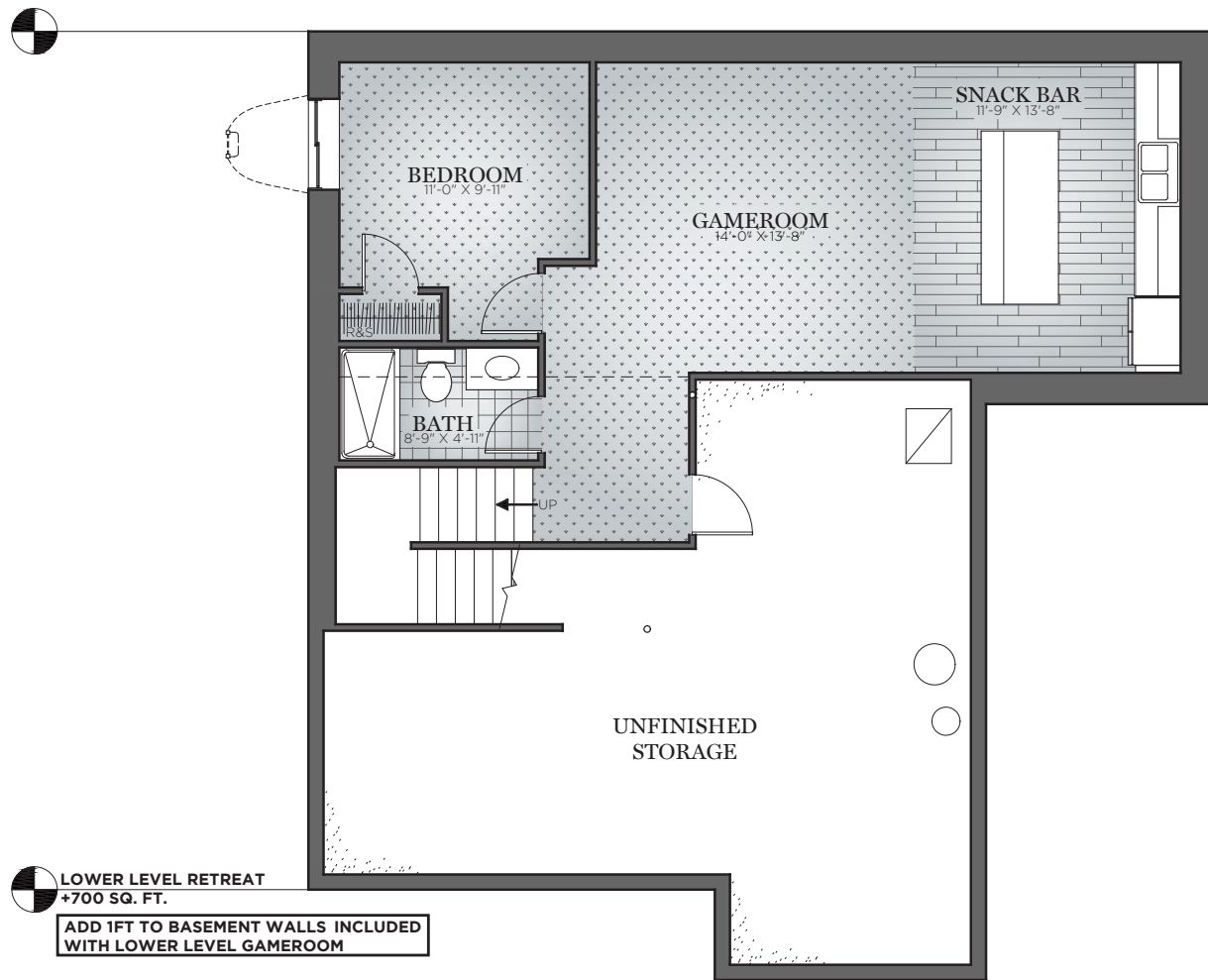

BASEMENT BATH ROUGH-IN NOT
 AVAILABLE WITH GAMEROOM OPTION
 ADD 1FT TO BASEMENT WALLS INCLUDED
 WITH LOWER LEVEL GAMEROOM
 LOWER LEVEL GAMEROOM
 +457 SQ. FT.

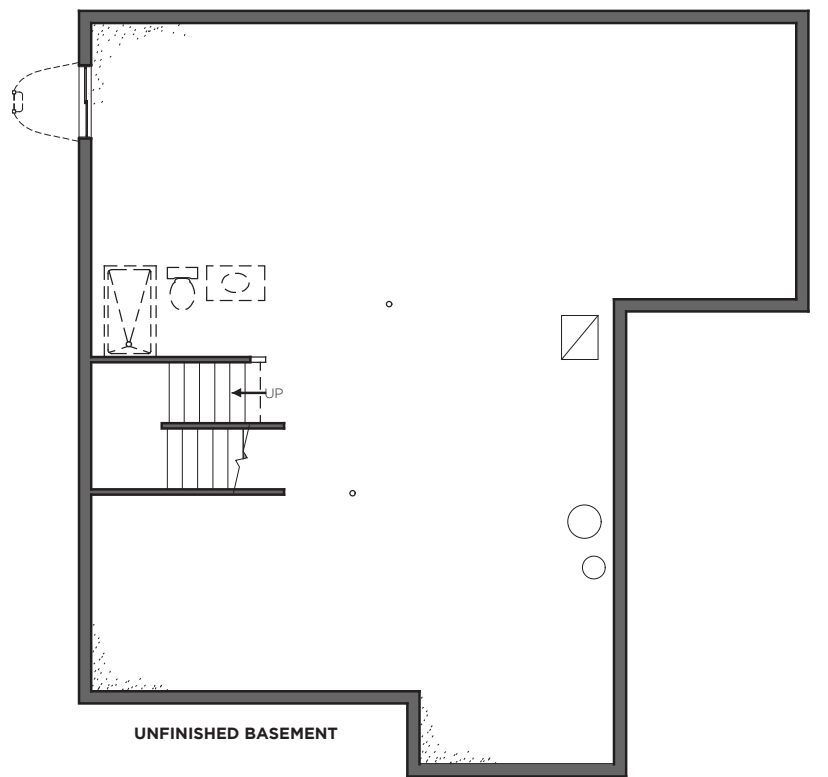

LOWER LEVEL MODIFY FLOOR PLAN
 OA DIMENSION 50 X 44

THE DRUMMOND



CHARTER Homes & Neighborhoods

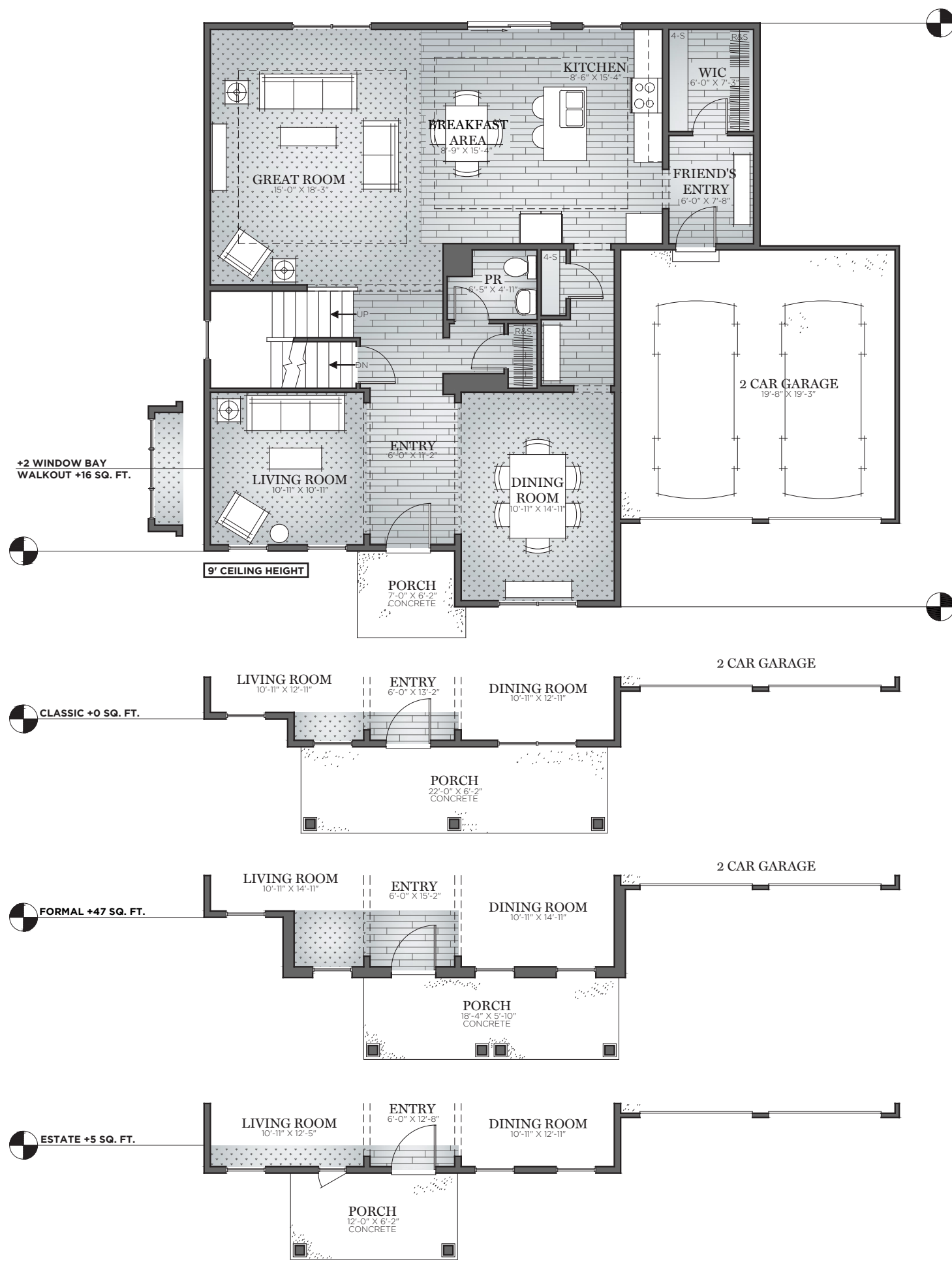

FIRST FLOOR MODIFY FLOOR PLAN
 OA DIMENSION 50 X 44

THE DRUMMOND



CHARTER Homes & Neighborhoods

Information included is for illustrative and marketing purposes only. Scale and dimensions are approximate and may vary based on normal construction tolerances. Renderings, materials, finishes and fixtures are intended for space demonstration only. Consult Neighborhood Sales Manager for accurate details based on individual conditions of Purchase Agreement.
 © 2016 Charter Homes & Neighborhoods. All rights reserved. Do not duplicate or distribute without written consent.

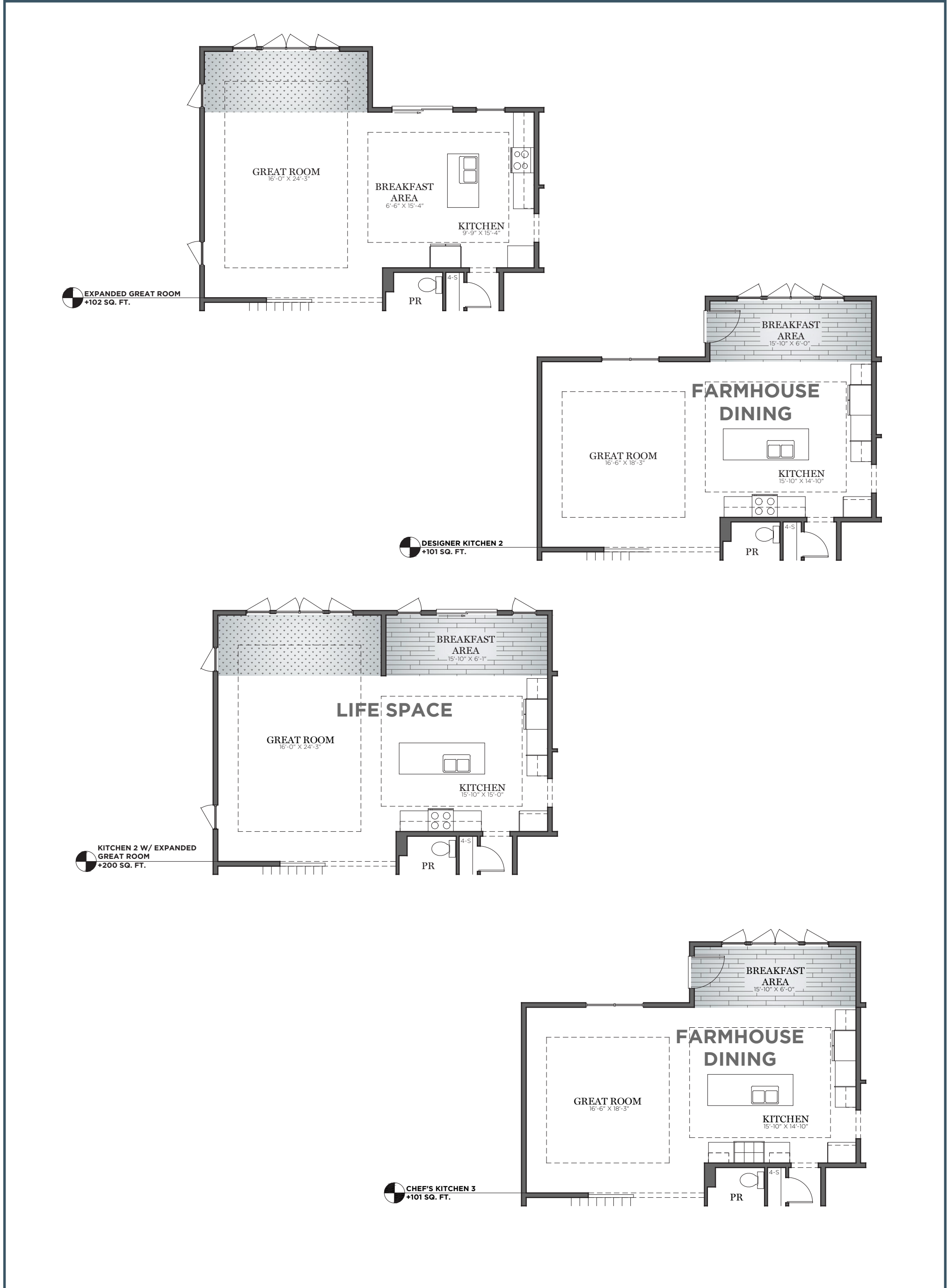

FIRST FLOOR MODIFY FLOOR PLAN
 OA DIMENSION 50 X 44

THE DRUMMOND



CHARTER Homes & Neighborhoods

Information included is for illustrative and marketing purposes only. Scale and dimensions are approximate and may vary based on normal construction tolerances. Renderings, materials, finishes and fixtures are intended for space demonstration only. Consult Neighborhood Sales Manager for accurate details based on individual conditions of Purchase Agreement.

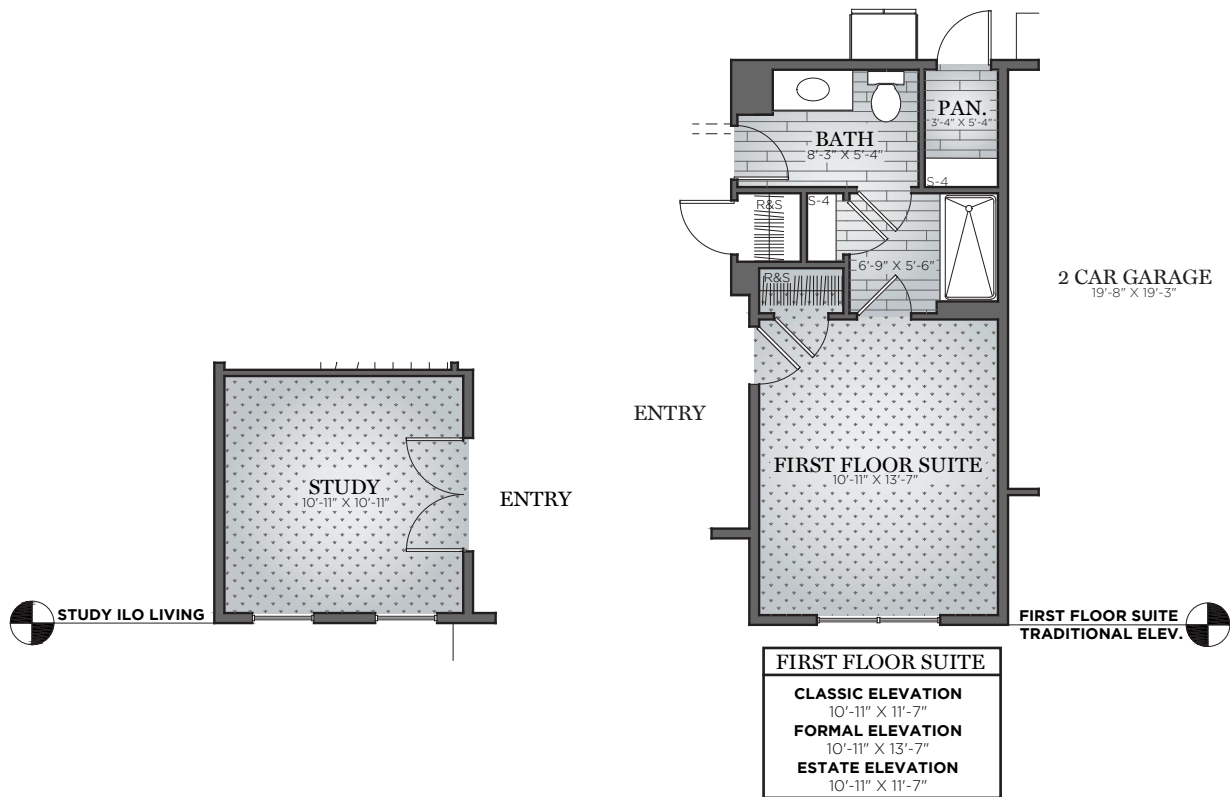
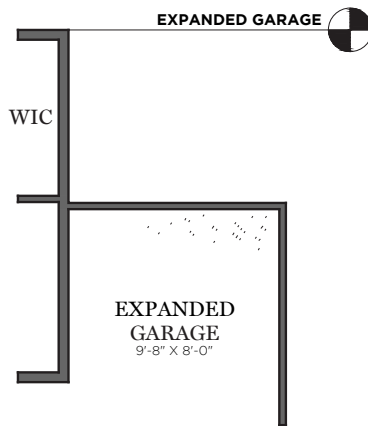
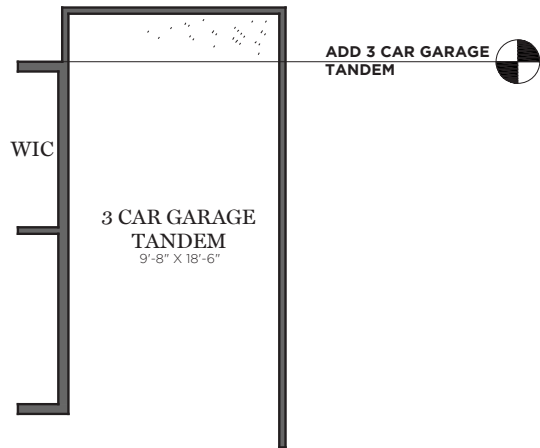
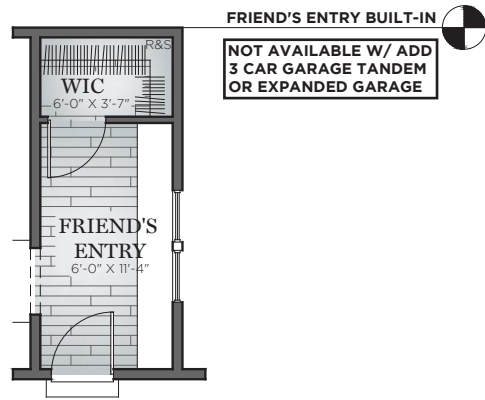

FIRST FLOOR MODIFY FLOOR PLAN
OA DIMENSION 50 X 44

THE DRUMMOND



CHARTER Homes & Neighborhoods

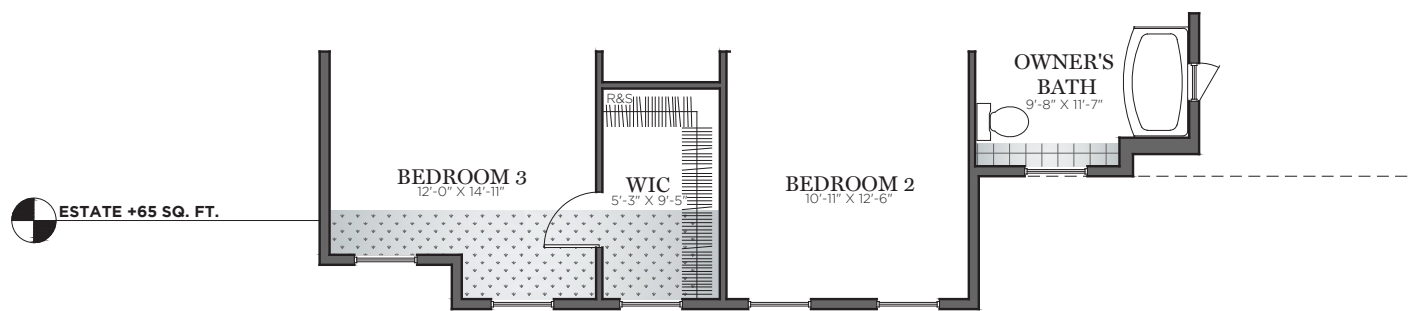
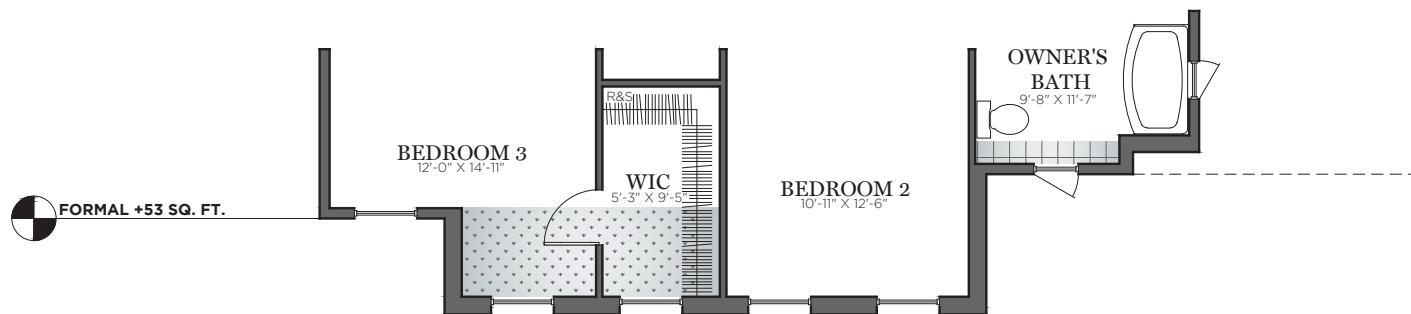
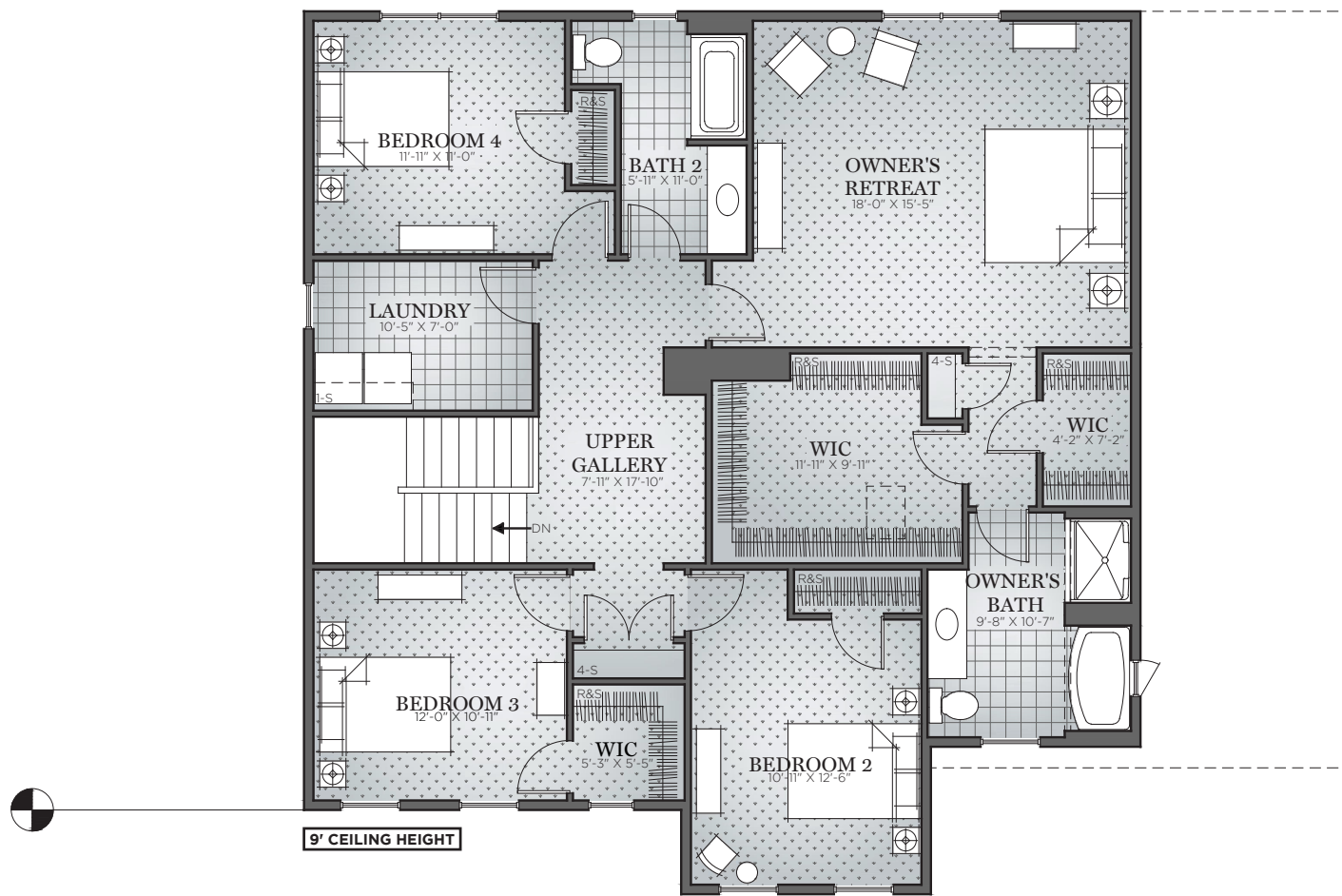

SECOND FLOOR **MODIFY FLOOR PLAN**
 OA DIMENSION 50 X 44

THE DRUMMOND



CHARTER Homes & Neighborhoods

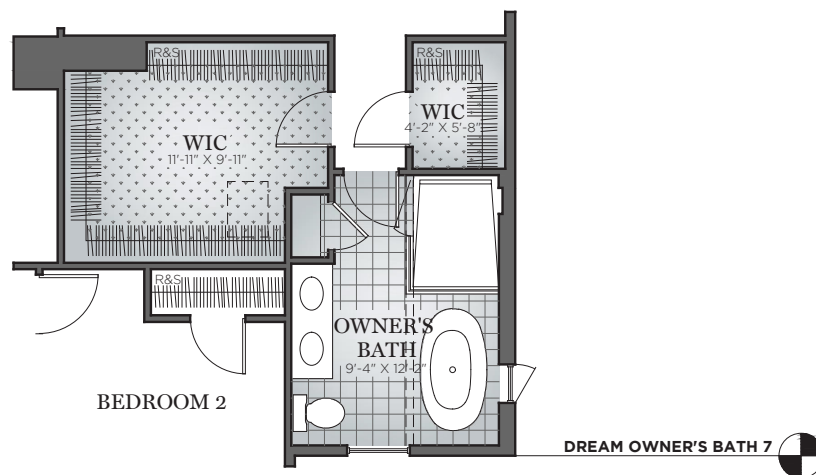
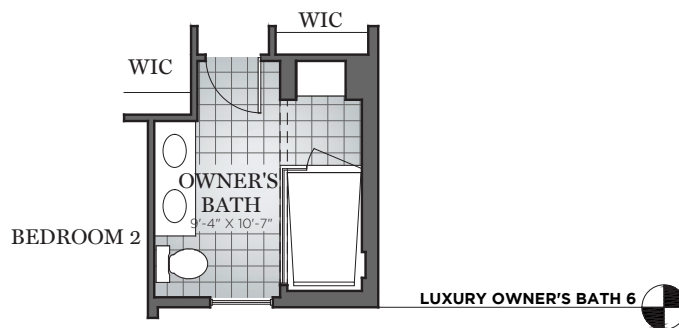
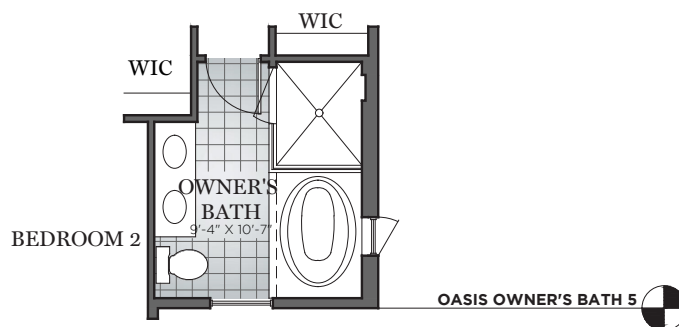
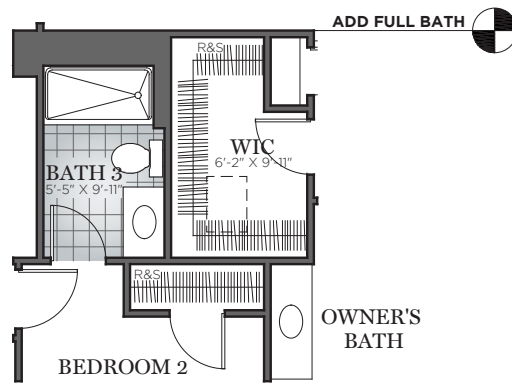

SECOND FLOOR **MODIFY FLOOR PLAN**
OA DIMENSION **50 X 44**

THE DRUMMOND



CHARTER Homes & Neighborhoods

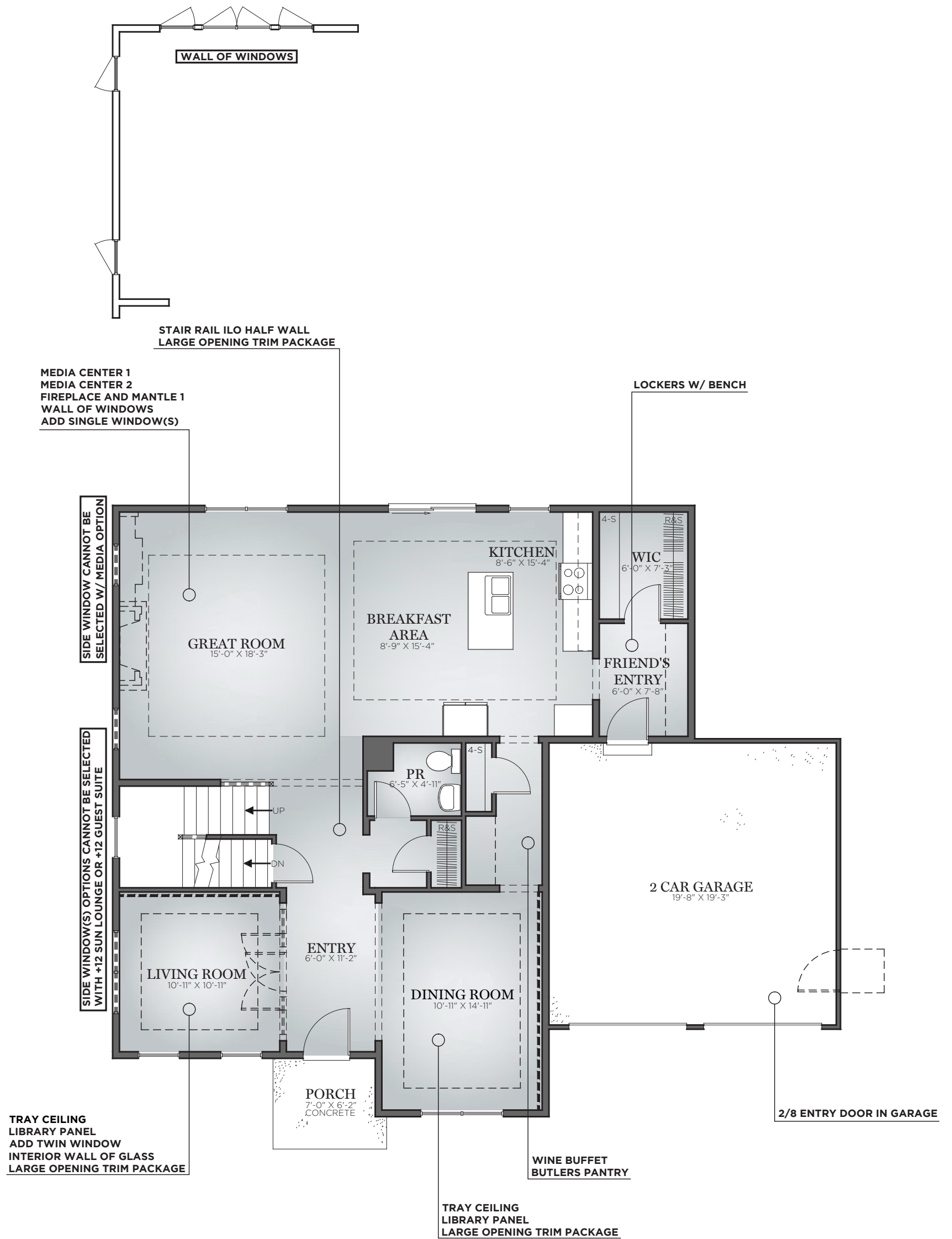

FIRST FLOOR ADD DETAILS

OA DIMENSION 50 X 44

THE DRUMMOND



CHARTER Homes & Neighborhoods

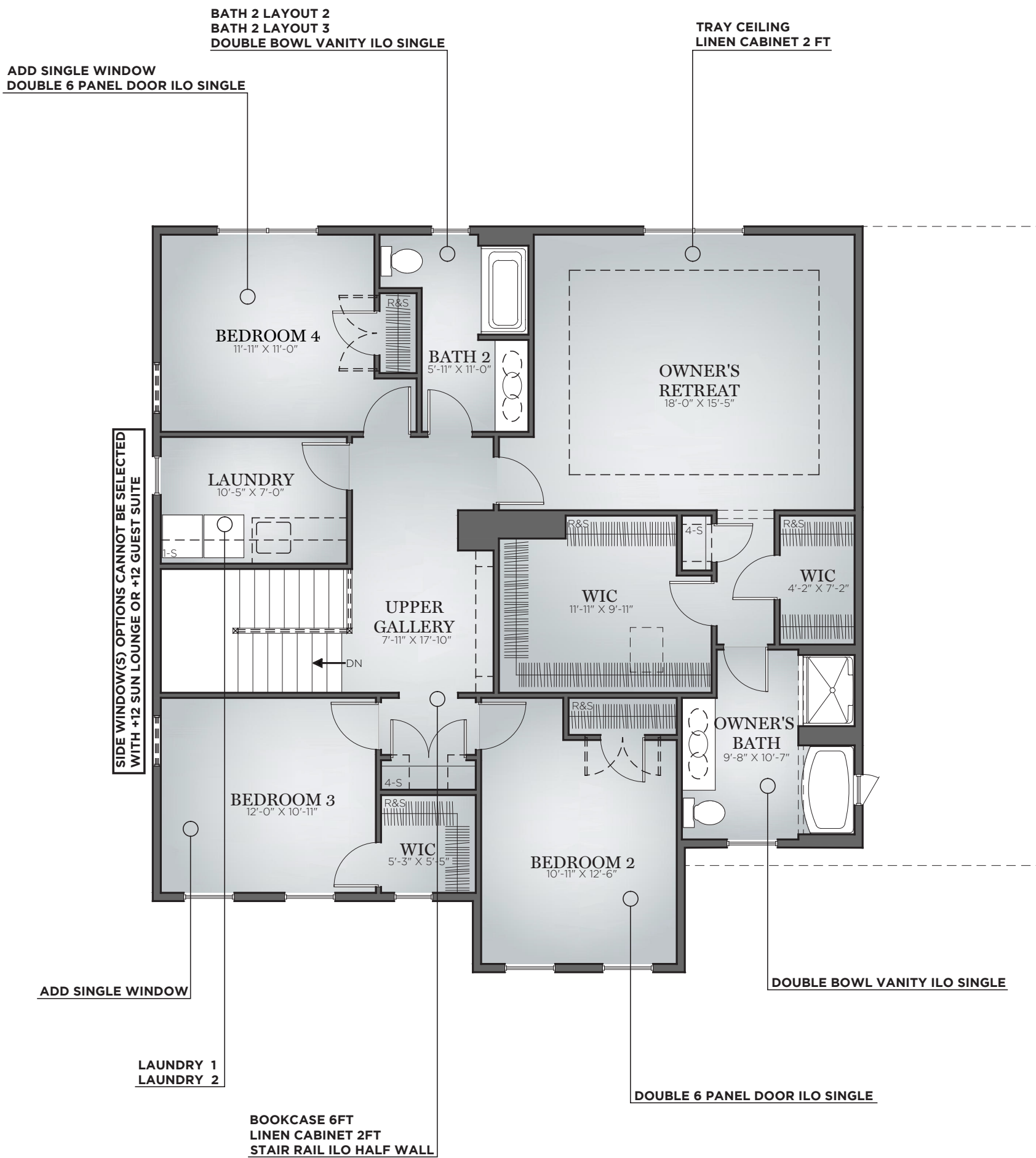

SECOND FLOOR ADD DETAILS
OA DIMENSION 50 X 44

THE DRUMMOND



CHARTER Homes & Neighborhoods



 **CHARTER** Homes & Neighborhoods

CLASSIC
KITCHEN B

THE DRUMMOND

Island Top Dimensions are 3'-1" x 5'-3"
 Wall Cabinet height 42"
 Appliance finish and features will vary per selection
 Refrigerator is not included in appliance package
 Finishes including cabinets, flooring, lighting, tile, plumbing,
 and hardware to be selected at Charter Colors
 Pendant lighting not included

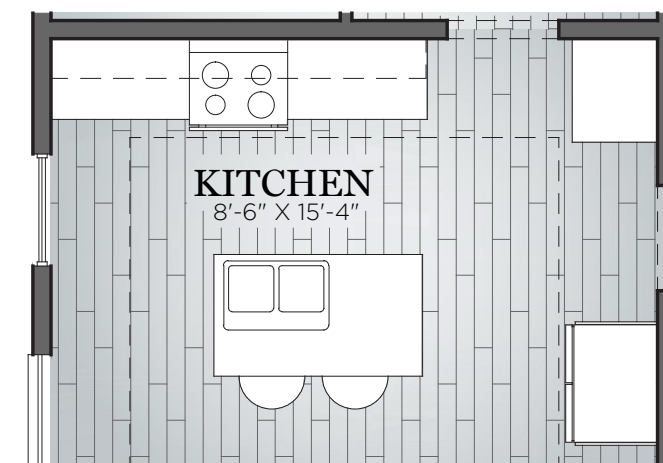

PLAN

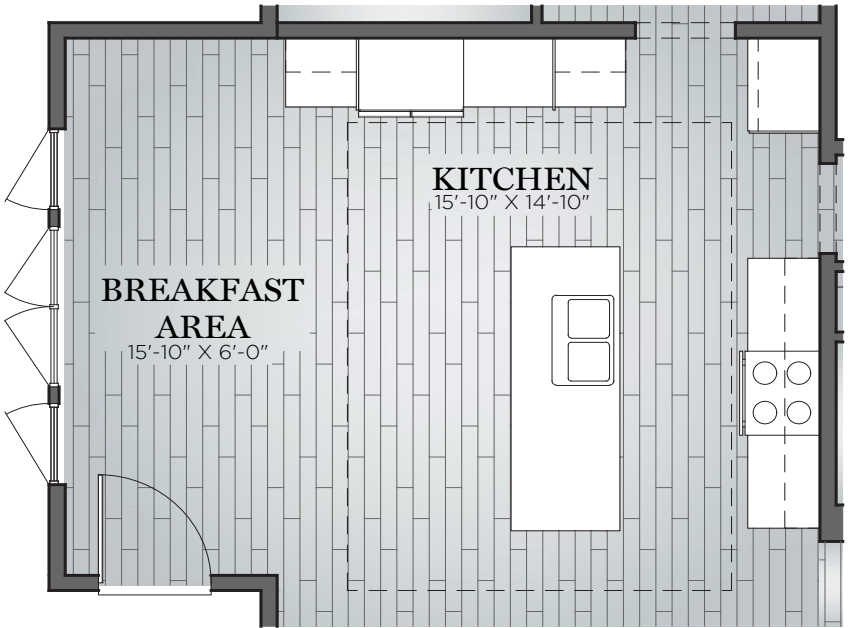

PLAN

 **CHARTER** Homes & Neighborhoods

DESIGNER
KITCHEN 2

THE DRUMMOND

Island Top Dimensions are 3'-1" x 8'-5"
 Wall Cabinet height 42"
 Appliance finish and features will vary per selection
 Refrigerator is not included in appliance package
 Finishes including cabinets, flooring, lighting, tile, plumbing,
 and hardware to be selected at Charter Colors
 Pendant lighting not included

Information included is for illustrative and marketing purposes only. Scale and dimensions are approximate and may vary based on normal construction tolerances. Renderings, materials, finishes and fixtures are intended for space demonstration only. Consult Neighborhood Sales Manager for accurate details based on individual conditions of Purchase Agreement. © 2016 Charter Homes & Neighborhoods. All rights reserved. Do not duplicate or distribute without written consent. ☎ 2936-3856 | 4 | 2.5 | v.2203



 **CHARTER** Homes & Neighborhoods

CHEF'S
KITCHEN 3

THE DRUMMOND

Island Top Dimensions are 3'-8" x 9'-2"
 Wall Cabinet height 42"
 Appliance finish and features will vary per selection
 Refrigerator is not included in appliance package
 Finishes including cabinets, flooring, lighting, tile, plumbing,
 and hardware to be selected at Charter Colors
 Pendant lighting not included

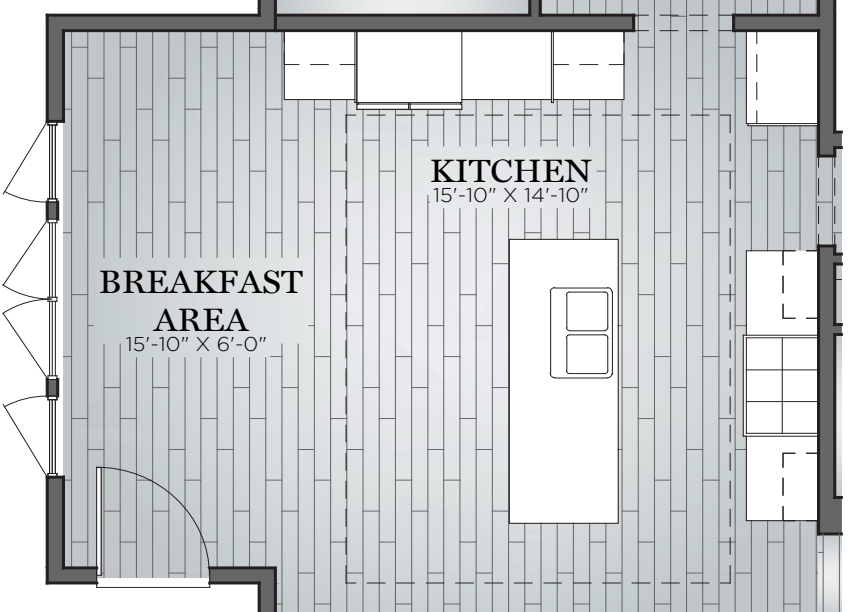

PLAN

Information included is for illustrative and marketing purposes only. Scale and dimensions are approximate and may vary based on normal construction tolerances. Renderings, materials, finishes and fixtures are intended for space demonstration only. Consult Neighborhood Sales Manager for accurate details based on individual conditions of Purchase Agreement. © 2016 Charter Homes & Neighborhoods. All rights reserved. Do not duplicate or distribute without written consent. 2936-3856 | 4 | 2.5 | v.2203



SPA OWNER'S BATH 4



BATH 3



BATH 2



BATH B

 **CHARTER** Homes & Neighborhoods

THE DRUMMOND

Tile locations vary per floorplan
 Bathroom layout varies per floorplan
 Finishes including plumbing, lighting, tile, vanities, sinks,
 and doors to be selected at Charter Colors



OASIS OWNER'S BATH 5



CHARTER Homes & Neighborhoods

THE DRUMMOND

Tile locations vary per floorplan
Bathroom layout varies per floorplan
Finishes including plumbing, lighting, tile, vanities, sinks,
and doors to be selected at Charter Colors



LUXURY OWNER'S BATH 6



TOWEL CUBBIE CABINET

- FULL REAR WALL OF TILE TO MATCH SHOWER SELECTION
- WOOD TOP WITH BACKSPLASH
- RECESSED LIGHT INCLUDED

THE DRUMMOND

Tile locations vary per floorplan
 Bathroom layout varies per floorplan
 Finishes including plumbing, lighting, tile, vanities, sinks,
 and doors to be selected at Charter Colors



DREAM OWNER'S BATH 7



CHARTER Homes & Neighborhoods

THE DRUMMOND

Tile locations vary per floorplan
Bathroom layout varies per floorplan
Finishes including plumbing, lighting, tile, vanities, sinks,
and doors to be selected at Charter Colors